

# › GN Series

## Panel Mount SSRs

### 24 to 280 VAC and 48-660 VAC

- › Current rating 10 and 125 Amps
- › Output voltage 24-280 VAC and 48-660 VAC
- › SCR Output for heavy industrial loads
- › Available with or without IP20 touch-safe cover
- › LED Status Indicator
- › UL Approved, CE Compliant to EN60950-1
- › Improved SEMS screw and washer
- › Redesigned housing with anti-rotation barriers
- › AC or DC control
- › EMC Compliant to Level 3
- › Epoxy Free Design



IP00 Package,  
Screw Terminal



IP00 Package,  
K option Hex Standoff



IP20 Package  
Screw Terminal

Previous version [click here](#)

Specific characteristics						
Control Voltage	10 Amp	25 Amp	50 Amp	75 Amp	100 Amp	125 Amp
3-32 VDC	84 134 000	84 134 010	84 134 020	84 134 030	84 134 040	84 134 080
18-36 VAC	84 134 002	84 134 012	84 134 022	84 134 032	84 134 042	84 134 082
90-280 VAC	84 134 001	84 134 011	84 134 021	84 134 031	84 134 041	84 134 081

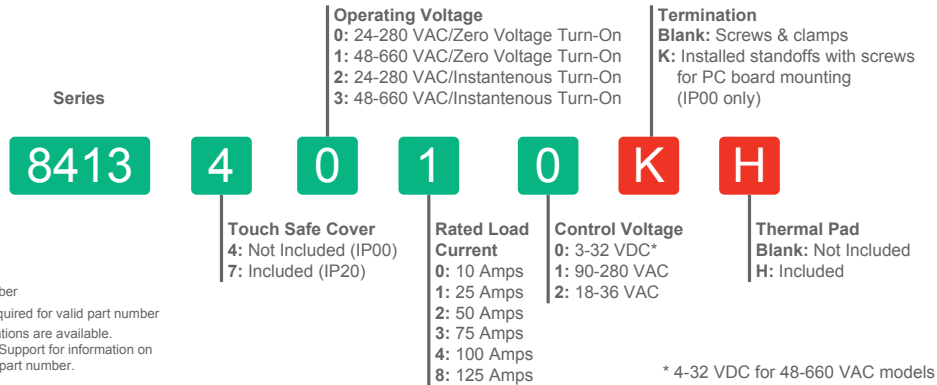

- Required for valid part number
- For options only and not required for valid part number
- > Not all part number combinations are available. Contact Crouzet Technical Support for information on the availability of a specific part number.

Output Specification		
Description	280 VAC	660 VAC
Operating Voltage (47-440Hz) [Vrms]	24-280	48-660
Transient Voltage [Vpk] <sub>(2)</sub>	600	1200
Maximum Off-State Leakage Current @ Rated Voltage [mArms]	0.1	0.25
Minimum Off-State dv/dt @ Maximum Rated Voltage [V/μsec]	500	500

**Output Specifications (1)**

Description	10A	25A	50A	75A	100A	125A
Maximum Load Current [Arms] (3)	10	25	50	75	100	125
Minimum Load Current [mArms]	50	50	100	100	100	100
Maximum 1 Cycle Surge Current (50/60Hz) [Apk]	150/175	275/300	710/750	1050/1100	1120/1200	1600/1700
1 Second Surge Current (Apk. Ta=25°C) 50/60 Hz	50	85	150	225	300	375
Maximum On-State Voltage Drop @ Rated Current [Vpk]	1.35	1.35	1.35	1.3	1.3	1.25
Thermal Resistance Junction to Case (Rjc) [°C/W]	0.4	0.4	0.25	0.16	0.16	0.11
Maximum 1/2 Cycle I <sup>2</sup> t for Fusing (50/60Hz) [A <sup>2</sup> sec]	110/120	380/370	2520/2320	5500/5000	6270/6000	12800/12050
Minimum Heat Sink for Rated Current @ 40°C [°C/W]	5	2	1	0.7	0.5	0.5

**Input Specifications (1)**

Description	8413xxx0	8413xxx2	8413xxx1
Control Voltage Range	3-32 VDC	18-36 VAC	90-280 VAC (5)
Maximum Reverse Voltage	-32 VDC	-	-
Minimum Turn-On Voltage	3 VDC (4)	18 VAC	90 VAC
Minimum Turn-Off Voltage	1 VDC	4 VAC	10 VAC
Minimum Input Current (for on-state)	10 mA	13 mA	6 mA
Maximum Input Current [mA]	15 mA	15 mA	10 mA
Nominal Input Impedance [Ohms]	Current Regulated	Current Regulated	Current Regulated
Maximum Turn-On Time [msec]	8.33 (6)	20	20
Maximum Turn-Off Time [msec]	8.33	30	30

**General Specifications (1)**

Description	Parameters
Dielectric Strength, Input/Output/Base (50/60Hz)	4000 Vrms
Minimum Insulation Resistance (@ 500 VDC)	10 <sup>9</sup> Ohms
Maximum Capacitance, Input/Output	8 pF
Ambient Operating Temperature Range (7)	-40 → +80 °C
Ambient Storage Temperature Range	-40 → +125 °C
Weight (typical)	2.53 oz (72 g)
Housing Material	UL94 V-0
Baseplate Material	Aluminum
Input Terminal Screw Torque Range (in-lbs/Nm)	13-15 / 1.5-1.7
Load Terminal Screw Torque Range (in-lbs/Nm)	18-20 / 2-2.2
SSR Mounting Screw Torque Range (in-lbs/Nm)	18-20 / 2-2.2
Input/Load Terminal Screw Torque Range (in-lbs/Nm) (8)	w/"K" option 8-10 / 0.9-1.13
Humidity	85% non-condensing
LED Input Status Indicator	Green
MTBF (Mean Time Between Failures) at 40°C ambient temperature (9)	11,641,553 hours (1,328 years)
MTBF (Mean Time Between Failures) at 60°C ambient temperature (9)	7,210,376 hours (823 years)

**General Notes**

- 1) All parameters at 25°C unless otherwise specified.
- 2) Output will self trigger between 450-600Vpk / 900-1200Vpk for 280VAC/660VAC models not suitable for capacitive loads.
- 3) Heat sinking required, see derating curves. For "K" option maximum current up to 50 Amp.
- 4) 4-32VDC for 48-660VAC models.
- 5) For ambient temperatures above 40°C the maximum control voltage must not exceed 250VAC.
- 6) Turn-on time for Instantaneous turn-on versions is 0.1 msec.
- 7) AC input models operating range is -20 to 80 °C.
- 8) Option "K" is intended only for use in attaching a printed circuit board to the SSR or mounting the SSR to a printed circuit board (PCB thicknesses from 0.031 to 0.093 inches [0.79 to 2.36 mm]).
- 9) All parameters at 50% power rating and 100% duty cycle (contact Crouzet technical support for detailed report).
- 10) Load can be wired to either SSR output terminal 1 or 2.
- 11) For single surge pulse Tc=25°C; Tj=125°C. For AC Output SSRs, AC Rms value of surge current equals the peak value divided by  $\sqrt{2}$  (1.414).

Diagrams

Wiring

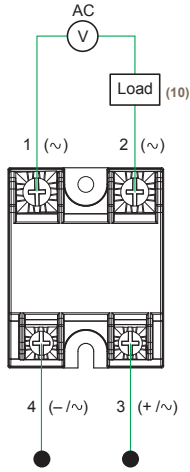

Recommended Wire Sizes		
Terminals	Wire Size (Solid / Stranded)	Wire Pull-Out Strength (lbs)[N]
Input	24 AWG (0.2 mm <sup>2</sup> ) / 0.2 [minimum]	10 [44.5]
	2 x 12 AWG (3.3 mm <sup>2</sup> ) / 3.3 [maximum]	90 [400]
Output	20 AWG (0.5 mm <sup>2</sup> ) / 0.518 [minimum]	30 [133]
	2 x 10 AWG (5.3 mm <sup>2</sup> ) / 5.3	110 [490]
	2 x 8 AWG (8.4 mm <sup>2</sup> ) / 8.4 [maximum]	90 [400]

Equivalent Circuit Block

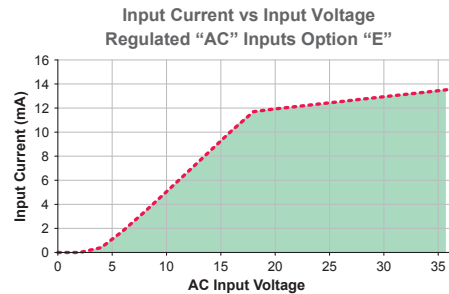
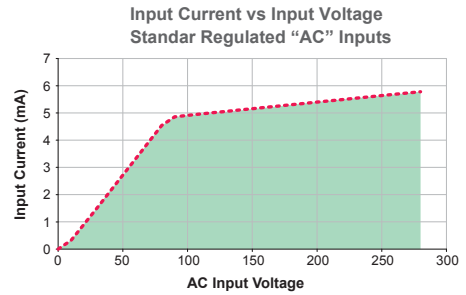
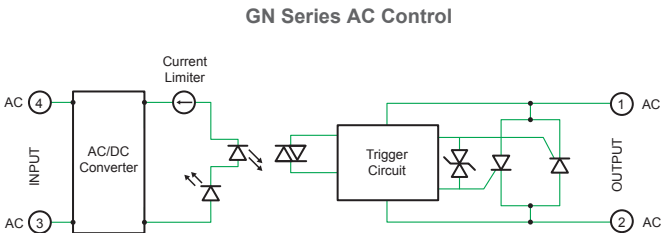
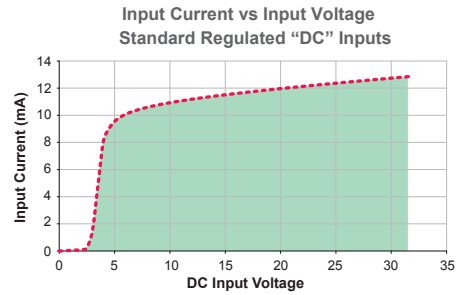
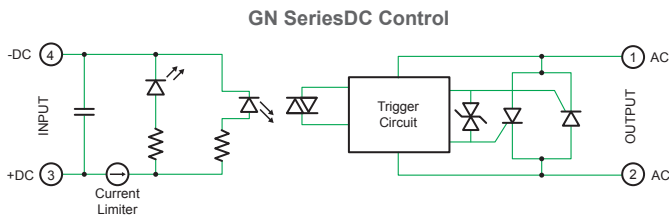

Dimensions in [mm]

Screw Termination

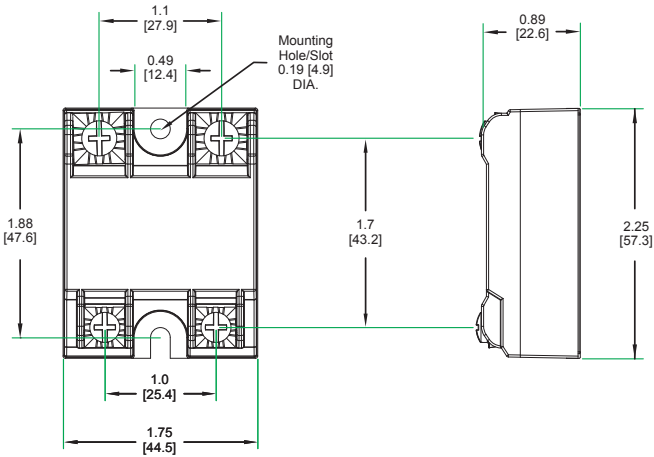

Hex Standoff Termination ("K" Option) (8)

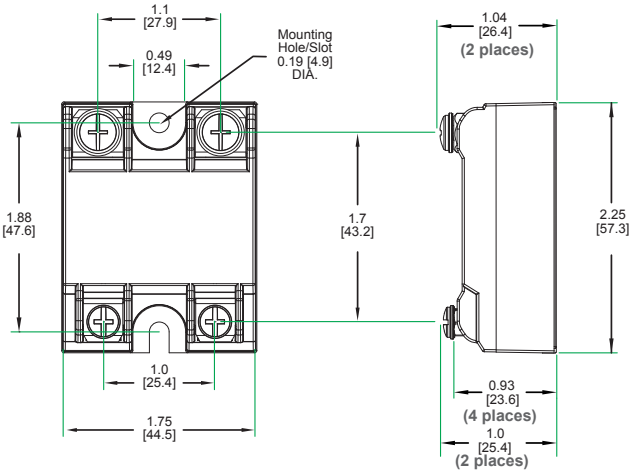

Screw Termination, IP20

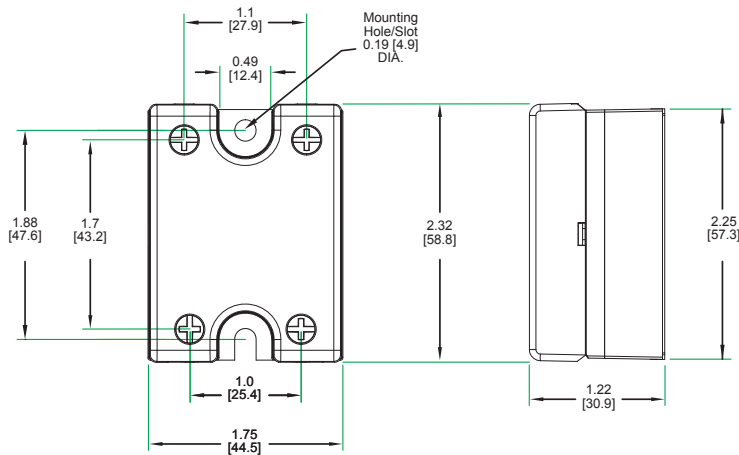

Tolerances: ±0.02 in / 0.5 mm  
All dimensions are in: inches [millimeters]

Curves

Thermal Derate Information

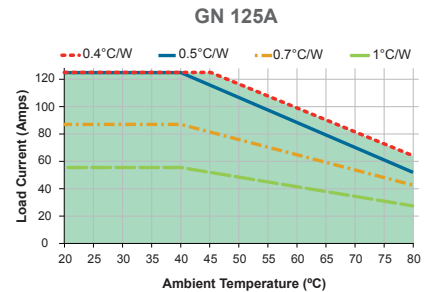
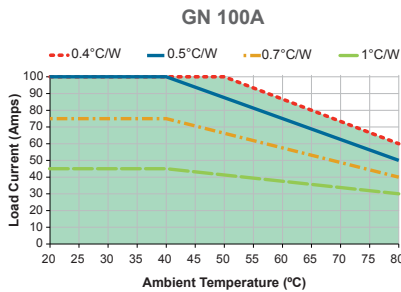
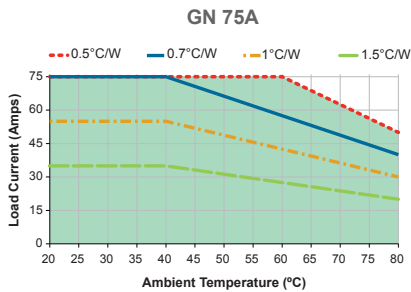
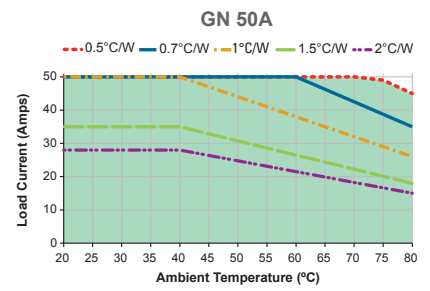
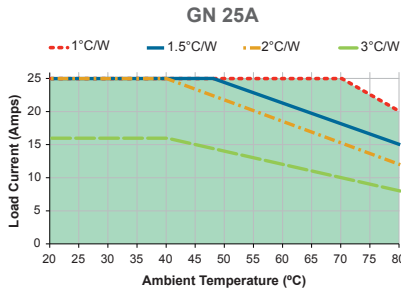
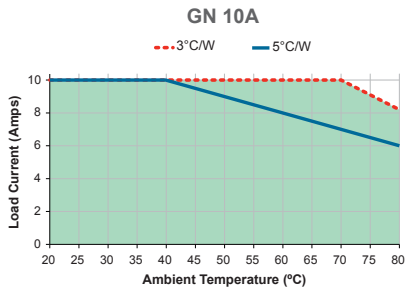

Curves

Surge Current Information --- Single Pulse (11)

GN 10A

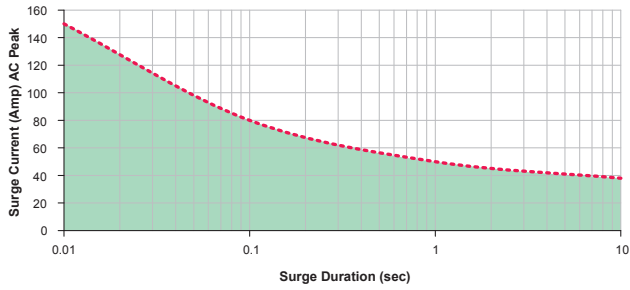

GN 25A

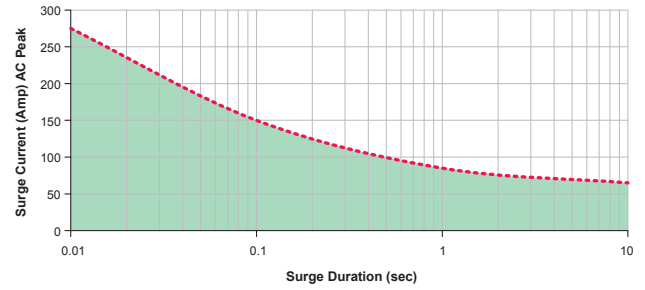

GN 50A

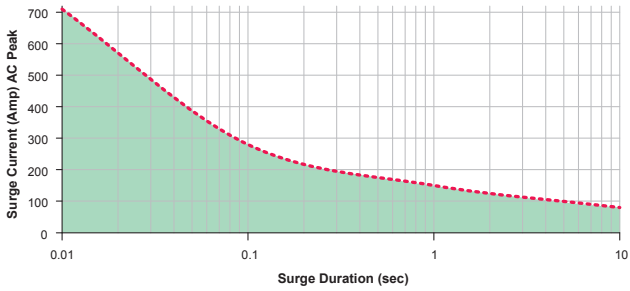

GN 75A

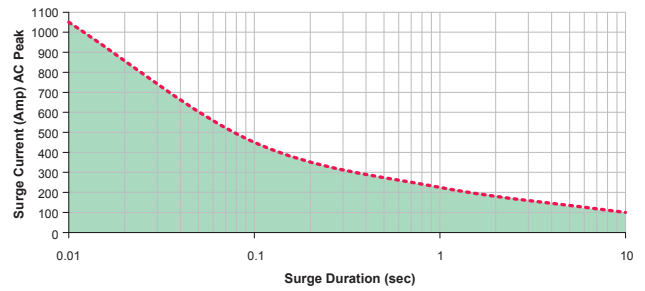

GN 100A

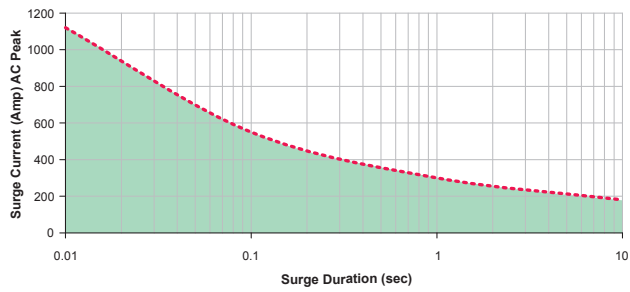

GN 125A

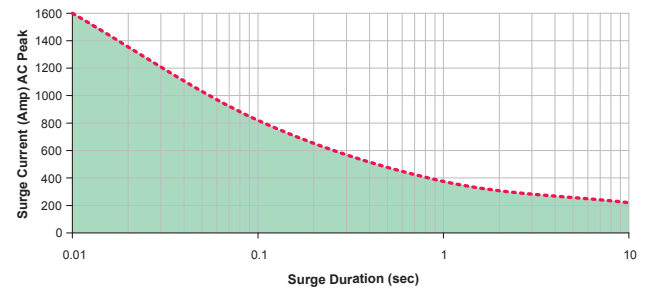

**Agency Approvals**

- › EN60950: Meets the requirements of sections 1.5: 1,7: 2.9: 2.10.5.3: 4.2: 4.5: 4.7: Certified according to EN 62314:2006
- IEC 61000-4-2 Electrostatic Discharge Level 3
- IEC 61000-4-4 Electrically Fast Transients Level 3
- IEC 61000-4-5 Electrical Surges Level 3

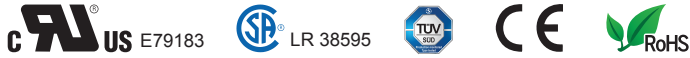

GN Series has Environmental Product declarations type III conforming to ISO 14025.

**Accessories**

**New Accessories!  
Protective Cover & Hardware Kits**

**Protective Cover  
Part number: KS101**







Clear plastic cover compatible with all new S1 designs. Safety covers provide added protection from electric shock when installing or checking equipment.

**Hardware Kit  
Part number: HK4**



Bag with 2 square brass accessories and 2 screw 8-32 x 5/8 for output. Used to mount TMR1 lug terminals.

**Recommended Accessories**

 Cover	 Hardware Kit	 Heat Sink Part No.	Thermal Resistance [°C/W]	 Lug Terminal	 Thermal Pad
KS101	HK1	HS501DR	5.0	TRM1	HSP-1
	HK4	HS301 / HS301DR	3.0	TRM6	HSP-2
		HS251	2.5		
		HS201 / HS201DR	2.0		
		HS202 / HS202DR	2.0		
		HS172	1.7		
		HS151 / HS151DR	1.5		
		HS122 / HS122DR	1.2		
		HS103 / HS103DR	1.0		
		HS101	1.0		
		HS073	0.7		
		HS072	0.7		
		HS053	0.5		
		HS033	0.36		
		HS023	0.25		

**⚠ DANGER / PELIGRO / DANGER /GEFAHR / PERICOLO / 危险**

<p><b>HAZARD OF ELECTRIC SHOCK, EXPLOSION, OR ARC FLASH.</b></p> <ul style="list-style-type: none"> <li>• Disconnect all power before installing or working with this equipment.</li> <li>• Verify all connections and replace all covers before turning on power.</li> </ul> <p><b>Failure to follow these instructions will result in death or serious injury.</b></p>	<p><b>RIESGO DE DESCARGA ELECTRICA O EXPLOSION.</b></p> <ul style="list-style-type: none"> <li>• Desconectar todos los suministros de energia a este equipo antes de trabajar con este equipo.</li> <li>• Verificar todas las conexiones y colocar todas las tapas antes de energizar el equipo.</li> </ul> <p><b>El incumplimiento de estas instrucciones puede provocar la muerte o lesiones serias.</b></p>	<p><b>RISQUE DE DESCARGE ELECTRIQUE OU EXPLOSION</b></p> <ul style="list-style-type: none"> <li>• Eteindre toutes les sources d'énergie de cet appareil avant de travailler dessus de cet appareil</li> <li>• Vérifier tous connections, et remettre tous couverts en place avant de mettre sous</li> </ul> <p><b>De non-suivi de ces instructions provoquera la mort ou des lésions sérieuses.</b></p>	<p><b>GEFAHR EINES ELEKTRISCHE N SCHLAGES ODER EINER EXPLOSION.</b></p> <ul style="list-style-type: none"> <li>• Stellen Sie jeglichen Strom ab, der dieses Gerät versorgt, bevor Sie an dem Gerät Arbeiten durchführen</li> <li>• Vor dem Drehen auf Energie alle Anschlüsse überprüfen und alle Abdeckungen ersetzen.</li> </ul> <p><b>Unterlassung dieser Anweisungen können zum Tode oder zu schweren Verletzungen führen.</b></p>	<p><b>RISCHIO DI SCOSSA ELETTRICA O DELL'ESPLOSIONE.</b></p> <ul style="list-style-type: none"> <li>• Spenga tutta l'alimentazione e che fornisca questa apparecchiatura prima del lavorare a questa apparecchiatura</li> <li>• Verificare tutti i collegamenti e sostituire tutte le coperture prima della rotazione sull'alimentazione</li> </ul> <p><b>L'omissione di seguire queste istruzioni provocherà la morte o di lesioni serie</b></p>	<p><b>存在电击、爆炸或电弧闪烁危险</b></p> <ul style="list-style-type: none"> <li>• 在操作此设备之前请先关闭电源。</li> </ul> <p><b>若不遵守这些说明,可能会导致严重的人身伤害甚至死亡。</b></p>
--	--	---	--	---	---

**⚠ WARNING / AVERTISSEMENT / WARNUNG /ADVERTENCIA / AVVERTENZA / 警告**

<p><b>RISK OF MATERIAL DAMAGE AND HOT ENCLOSURE</b></p> <ul style="list-style-type: none"> <li>• The product's side panels may be hot, allow the product to cool before touching.</li> <li>• Follow proper mounting instructions including torque values.</li> <li>• Do not allow liquids or foreign objects to enter this product.</li> </ul> <p><b>Failure to follow these instructions can result in serious injury, or equipment damage.</b></p>	<p><b>RISQUE DE DOMMAGE MATERIEL ET DE SURCHAUFFE DU BOITIER</b></p> <ul style="list-style-type: none"> <li>• Les panneaux latéraux du produit peuvent être chauds. Laisser le produit refroidir avant de le toucher.</li> <li>• Respecter les consignes de montage, et notamment les couples de serrage.</li> <li>• Ne pas laisser pénétrer de liquide ni de corps étrangers à l'intérieur du produit.</li> </ul> <p><b>Le non-respect de cette directive peut entraîner, des lésions corporelles graves ou des dommages matériels.</b></p>	<p><b>GEFAHR VON MATERIALSCHÄDEN UND GEHÄUSEERHITZUNG</b></p> <ul style="list-style-type: none"> <li>• Die Seitenwände können heiß sein. Lassen Sie das Produkt abkühlen, bevor Sie es berühren.</li> <li>• Beachten Sie die Montageanweisungen, Führen Sie keine Flüssigkeiten oder Fremdkörper in das Produkt ein.</li> </ul> <p><b>Die Nichtbeachtung dieser Anweisung kann Körperverletzung oder Materialschäden zur Folge haben.</b></p>
<p><b>RIESGO DE DAÑOS MATERIALES Y DE SOBRECALENTAMIENTO DE LA UNIDAD</b></p> <ul style="list-style-type: none"> <li>• Los paneles laterales del producto pueden estar calientes. Esperar que el producto se enfríe antes de tocarlo.</li> <li>• Respetar las instrucciones de montaje, y en particular los pares de apretado.</li> <li>• No dejar que penetren líquidos o cuerpos extraños en el producto.</li> </ul> <p><b>Si no se respetan estas precauciones pueden producirse graves lesiones, daños materiales.</b></p>	<p><b>RISCHIO DI DANNI MATERIALI E D'INVOLUCRO CALDO</b></p> <ul style="list-style-type: none"> <li>• I pannelli laterali dell'apparecchio possono scottare; lasciar quindi raffreddare il prodotto prima di toccarlo.</li> <li>• Seguire le istruzioni di montaggio corrette.</li> <li>• Non far entrare liquidi o oggetti estranei in questo apparecchio.</li> </ul> <p><b>La mancata osservanza di questa precauzione può causare gravi rischi per l'incolumità personale o danni alle apparecchiature.</b></p>	<p><b>材料损坏和高温外壳的危险性</b></p> <ul style="list-style-type: none"> <li>• 产品的一侧面板可能很热, 在其冷却前请不要触碰。</li> <li>• 遵照正确的安装说明, 包括扭矩值。</li> <li>• 请勿让液体及其他异物进入本产品。</li> </ul> <p><b>如不能正确执行这些操作说明, 极有可能造成严重人体伤害或者设备的损坏。</b></p>

## ANNEX - ENVIROMENTAL INFORMATION

The environmental information disclosed in this annex including the EIP Pollution logo are in compliance with People's Republic of China Electronic Industry Standard SJ/T11364 – 2006, Marking for Control of Pollution Caused by Electronic Information Products.

Part Name	Toxic or hazardous Substance and Elements					
	Lead (Pb)	Mercury (Hg)	Cadmium (Cd)	Hexavalent Chromium (Cr (VI))	Polybrominated biphenyls (PBB)	Polybrominated diphenyl ethers (PBDE)
Semiconductor die	X	O	O	O	O	O
Solder	X	O	O	O	O	O

### 附件 - 环保信息

此附件所标示的包括电子信息产品污染图标的环保信息符合中华人民共和国电子行业标准 SJ/T11364 - 2006, 电子信息产品污染控制标识要求。

部件名称	有毒有害物质或元素					
	铅 (Pb)	汞 (Hg)	镉 (Cd)	六价铬 (Cr (VI))	多溴联苯 (PBB)	多溴二苯醚 (PBDE)
半导体芯片	X	O	O	O	O	O
焊接点	X	O	O	O	O	O

